

REVISED 7/1/20

PRODUCT

JUNIP PENDANT
JUNIP 02-001

MATERIALS (FINISHES)

ANODIZED ALUMINUM (AGED
BRONZE, GOLDEN BRASS, SATIN
BLACK, SATIN SILVER)

GLASS (CLEAR, FROSTED, SMOKE)

WEIGHT

2.5 LBS

LAMPING

INTEGRATED LED (QTY 2)
13W, 3000K
DIMMABLE

CANOPY / CORD

ROUND CANOPY
9' BLACK CORD (CLOTH COVERED)

CERTIFICATIONS

ETL LISTED (120V, US/CANADA)

NOTES

JUNIP IS COMPRISED OF MODULAR
COMPONENTS AND IS MEANT TO
BE ASSEMBLED ON-SITE BY A
QUALIFIED AND LICENSED
ELECTRICIAN AND INSTALLATION
PROFESSIONAL.

PATENT PENDING



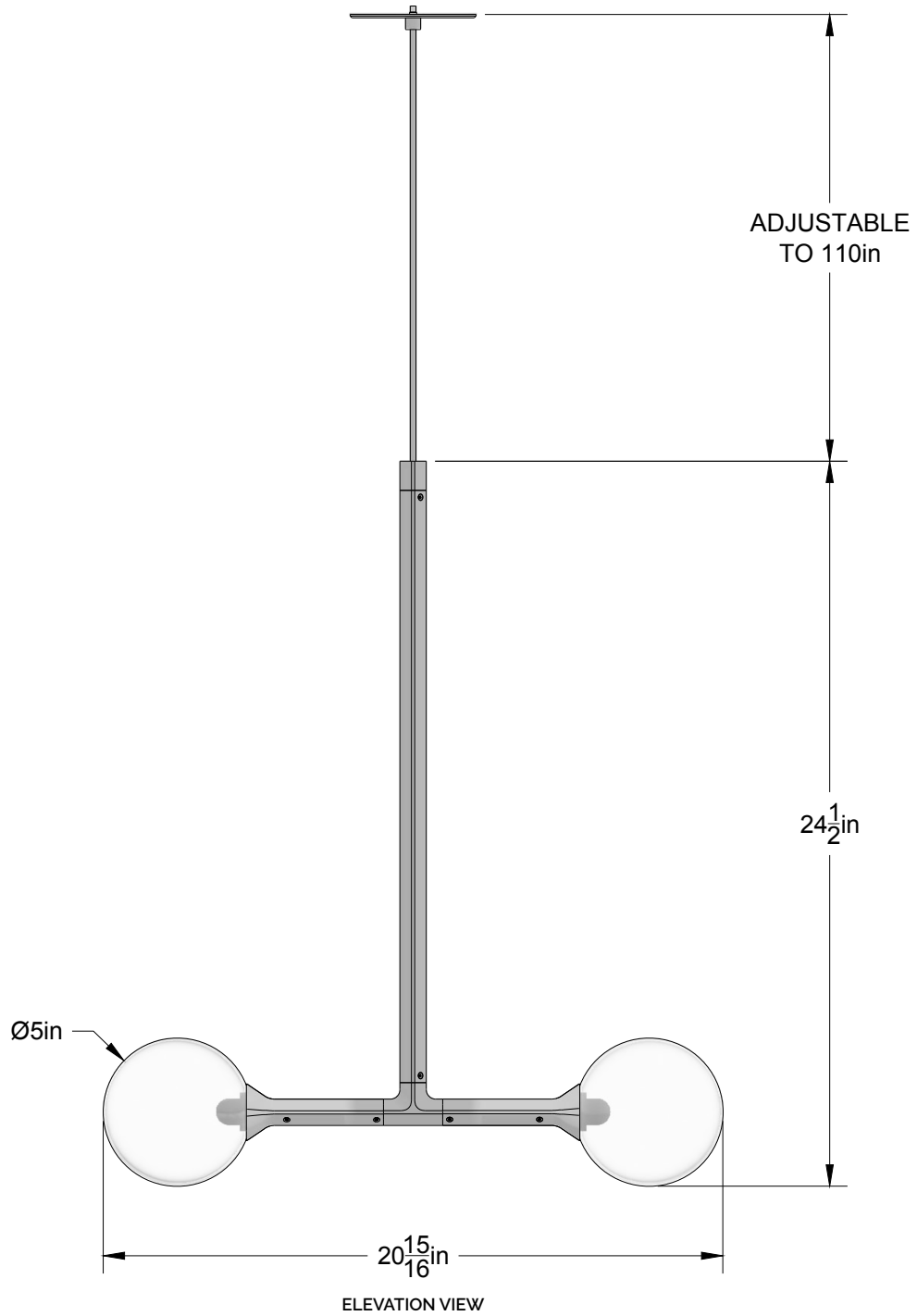

© 2020, LAKE AND WELLS, LLC. ALL RIGHTS RESERVED