

REVISED 12/1/19

PRODUCT

JOULLE CHANDELIER
JOULLE 03-001

MATERIALS (FINISHES)

ANODIZED ALUMINUM (AGED
BRONZE, GOLDEN BRASS, SATIN
BLACK, SATIN SILVER)

SOLID OPTIC CRYSTAL (CLEAR,
FROSTED, SMOKE)

WEIGHT

3.1 LBS

LAMPING

INTEGRATED LED (QTY 3)
13W, 3000K
DIMMABLE

CERTIFICATIONS

ETL LISTED (120V, US/CANADA)

NOTES

JOULLE IS COMPRISED OF
MODULAR COMPONENTS AND IS
MEANT TO BE ASSEMBLED ON-
SITE BY A QUALIFIED AND
LICENSED ELECTRICIAN AND
INSTALLATION PROFESSIONAL.

PATENT PENDING



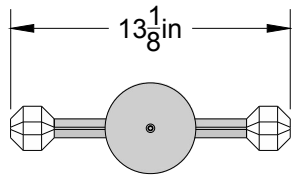

PLAN VIEW

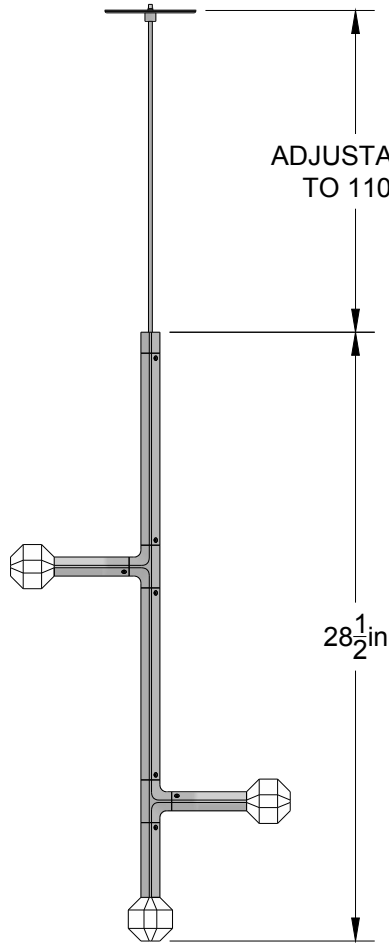

ELEVATION VIEW

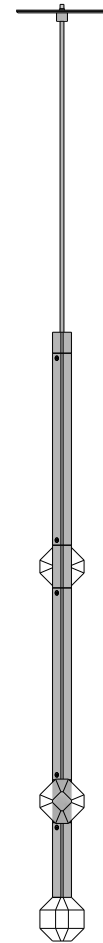

SIDE VIEW

© 2019, LAKE AND WELLS, LLC ALL RIGHTS RESERVED