

REVISED 7/1/19

PRODUCT

JAX SCONCE
JAX WALL 06-003

MATERIALS (FINISHES)

ANODIZED ALUMINUM (AGED
BRONZE, GOLDEN BRASS, SATIN
BLACK, SATIN SILVER)

SOLID OPTIC CRYSTAL (CLEAR,
FROSTED, SMOKE)

WEIGHT

6.7 LBS

LAMPING

INTEGRATED LED (QTY 6)
13W, 3000K
DIMMABLE

CERTIFICATIONS

ETL LISTED (120V, US/CANADA)

NOTES

JAX IS COMPRISED OF MODULAR
COMPONENTS AND IS MEANT TO
BE ASSEMBLED ON-SITE BY A
QUALIFIED AND LICENSED
ELECTRICIAN AND INSTALLATION
PROFESSIONAL.

PATENT PENDING



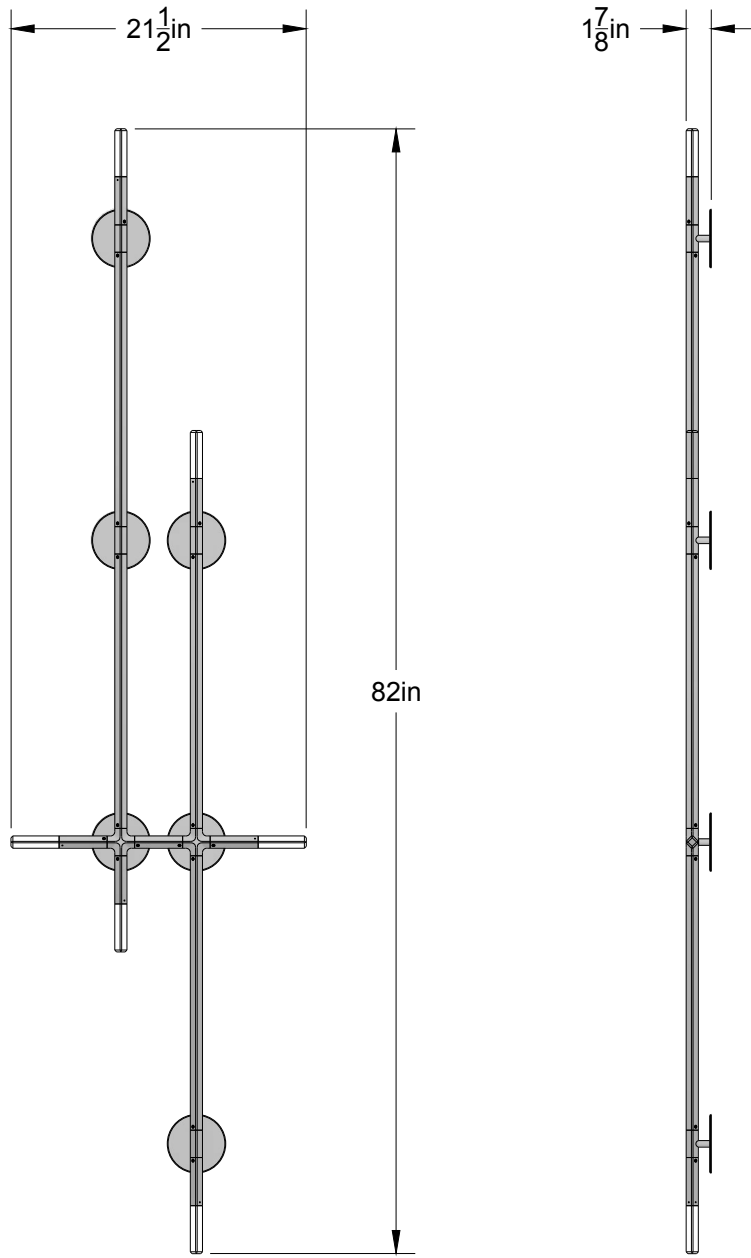

ELEVATION VIEW

SIDE VIEW

© 2019, LAKE AND WELLS, LLC ALL RIGHTS RESERVED