

REVISED 6/1/19

PRODUCT

JAX CHANDELIER
JAX 24-003

MATERIALS (FINISHES)

ANODIZED ALUMINUM (AGED
BRONZE, GOLDEN BRASS, SATIN
BLACK, SATIN SILVER)

SOLID OPTIC CRYSTAL (CLEAR,
FROSTED, SMOKE)

WEIGHT

13.0 LBS

LAMPING

INTEGRATED LED (QTY 24)
13W, 3000K
ELV AND PHASE DIMMABLE

CERTIFICATIONS

ETL LISTED (120V)

NOTES

JAX IS COMPRISED OF MODULAR
COMPONENTS AND IS MEANT TO
BE ASSEMBLED ON-SITE BY A
QUALIFIED ELECTRICIAN AND
INSTALLATION PROFESSIONAL.

PATENT PENDING



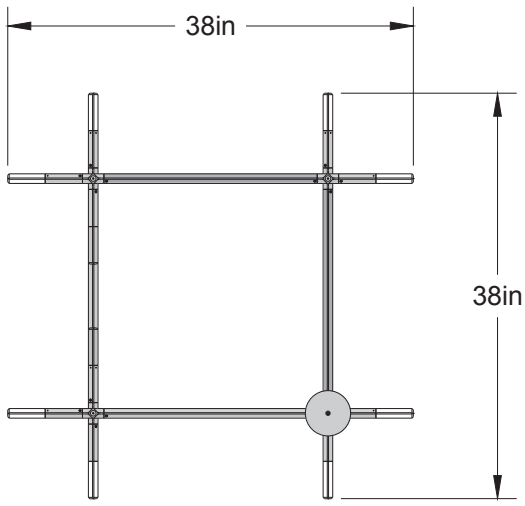

PLAN VIEW

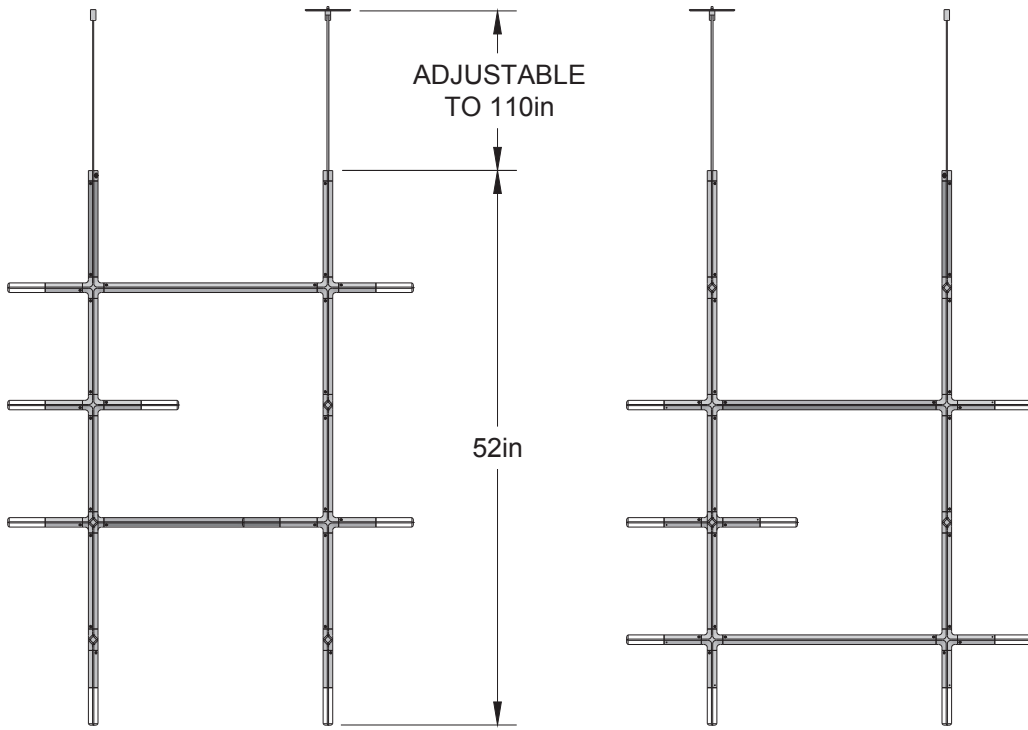

ELEVATION VIEW

SIDE VIEW

© 2019, LAKE AND WELLS, LLC ALL RIGHTS RESERVED